



# **Vulcanic**



**TEMPERATURE CONTROL SYSTEMS  
ELECTRICAL HEATING AND COOLING  
SOLUTIONS FOR THE INDUSTRY**

**[www.vulcanic.com](http://www.vulcanic.com)**



## Vulcanic

The Vulcanic group has been designing and manufacturing electrical process heating and temperature control solutions for safe and hazardous areas since 1973. Employing 600 people across 8 manufacturing locations worldwide, Vulcanic currently services 30 000 customers in more than 100 different countries across the globe and is an ISO 9001 v 2008 accredited company.



## Engineered Projects

The engineering projects division of Vulcanic is a world leader for designing and manufacturing of electrical process heating and cooling systems as well as temperature control solutions. For that reason we are able to meet the requirements of varying customer specifications and international standards. Our extensive experience covers many industries and extreme environments in both on and offshore locations.

## Design Expertise

Vulcanic design teams support our partners from conceptual design and feasibility study throughout the life cycle of the equipment. Our design capabilities include:

- Process heater design
- Electrical design
- Mechanical design
- Hazardous area certification
- Thermal design
- Electronic design (hardware and software)
- Temperature Control design

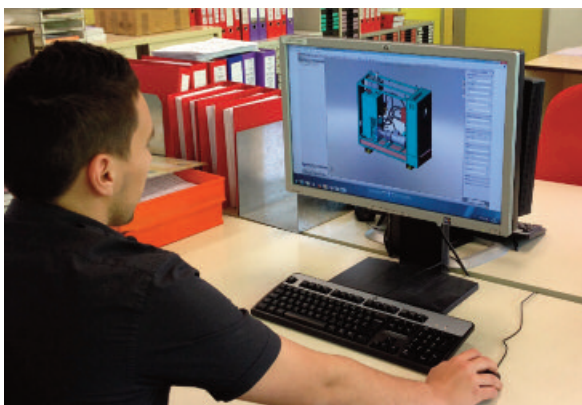



# Main applications



## POLYMERS

- Thermoforming
- Blow Moulding
- Rubber Mixing
- Calendering
- Extrusion
- Vulcanization



## AERONAUTICAL

- Resin Transfer Moulding (RTM)
- Thermoset Transfer / Compression Moulding
- Thermoplastic Injection Moulding



## AUTOMOTIVE

- Engine test bench
- Robot welding
- High Speed Machining (HSM)
- Electrical / Electronical cabinet cooling
- Stamping
- Spraying equipment

## CHEMICAL / PHARMACEUTICAL

- Reaction unit
- Pipe tracing
- Glass reactor
- Pressure reactor / Autoclave
- Heat exchanger
- Evaporator



## FOOD & BEVERAGE

- Double jacket vessel heating & cooling
- Mixer
- Melter
- Tempering machine
- Evaporator



## ALTERNATIVE ENERGIES

- Solar panel test bench
- Heat pump test bench
- Heat exchanger test bench
- Laser source





# VULCATHERM® TEMPERATURE CONTROL UNITS



- CUSTOMISED SOLUTION
- PLUG & PLAY
- EASY ACCESS
- QUICK RESPONSE TIME
- ACCURATE TEMPERATURE CONTROL
- REDUCED MAINTENANCE
- HIGH EFFICIENCY
- LONG SERVICE LIFE OF THE THERMAL FLUID
- ELECTRICAL EXPANSION & PRESSURISATION

## PURPOSE

The VULCATHERM® product range consists on high-quality and efficient electrical temperature control units, using oil or water as a heat transfer medium, as well as air or water-cooled chillers with integrated cooling circuit. We can provide a wide range of units to suit your specific application and requirements.

## COMMUNICATION

Centralized Management System provides fully automated process monitoring. The integrated display offers multilingual operation menus with enhanced information in case of troubleshooting.

- Communication with a wide range of industrial interfaces : RS485, TCP/IP, Profibus dP, Modbus, Canbus, etc...
- Remote input/output exchange signals : ON/OFF, Local/Remote mode selection, reset, alarms...
- Analog Signal Exchange (4/20 mA or 0/10 V).
- Multilingual message indications.
- Accurate process value display : Temperature, Pressure, Flow rate, Alarm report, Maintenance.



CMS.v2

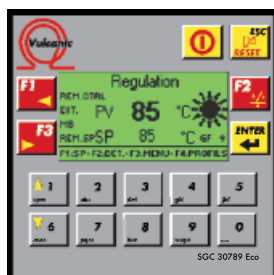

CMS «Eco»



CMS.v3  
Touch Screen

# VULCATHERM® TEMPERATURE CONTROL UNITS



**HEATING / COOLING** Direct or Indirect cooling with cold water exchanger  
Air-Cooling on request

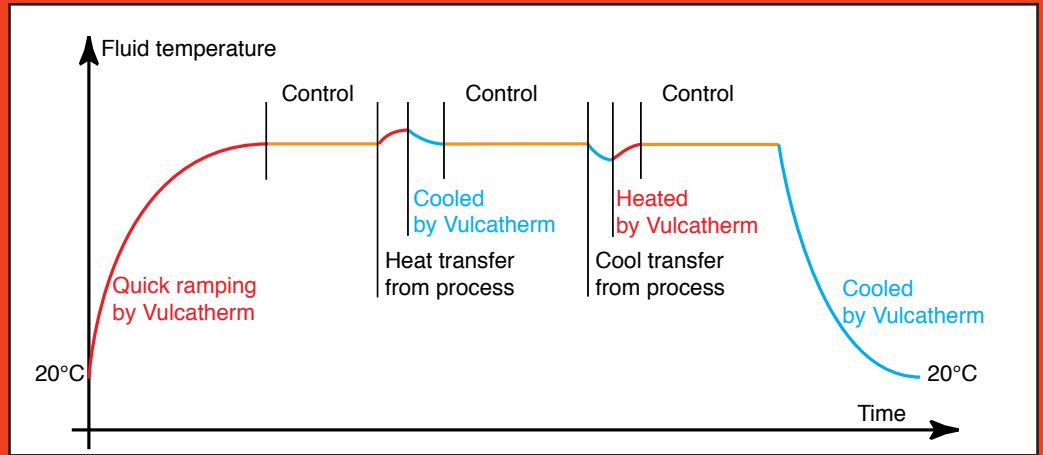

## PURPOSE

VULCATHERM® achieves heating, cooling and control of a fluid medium in closed loop through a process application (mould, tank, bench,...). The medium is cooled through an exchanger fed by the customer's water circuit or recycled water system.

## PERFORMANCES

- : Temperature 90 to 180°C/200°C
- : Temperature 180 to 350°C/400°C
- : Heating Capacity 4 to 245 kW
- : Cooling Capacity 16 to 450 kW depending on customer water circuit

## CHARACTERISTICS

- Electrical heater : Compact technology with continuous heater surface temperature to prevent degradation of fluid
- PID Temperature control.
- Heating capacity control by thyristors.
- Direct or indirect cooling controlled by on/off.
- Fluid superposition technology®
- Centrifugal pump.
- Atmospheric or pressurised (up to 200°C for water medium and 400°C for oil medium).

## LAYOUT

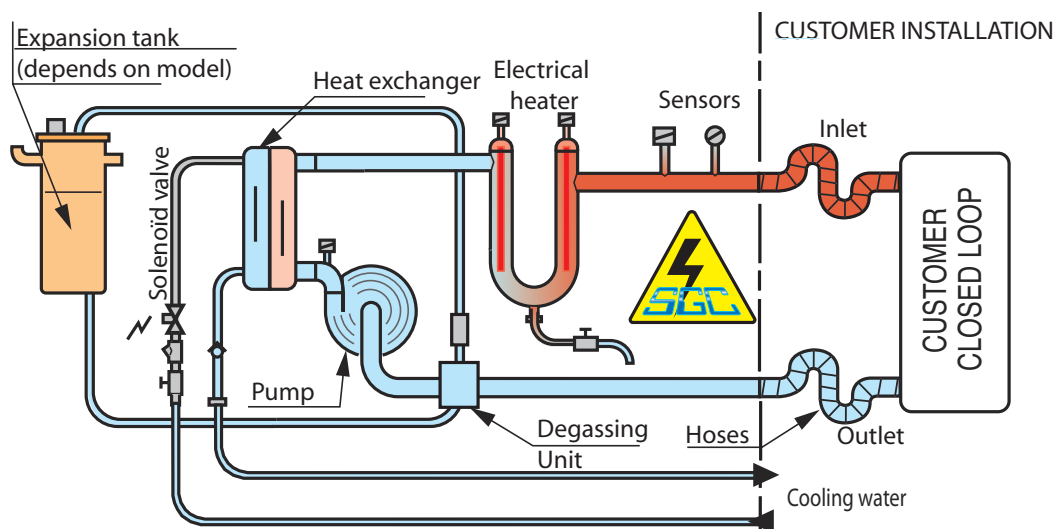



# VULCATHERM® TEMPERATURE CONTROL UNITS

## HEATING / COOLING WITH INTEGRATED COOLING UNIT



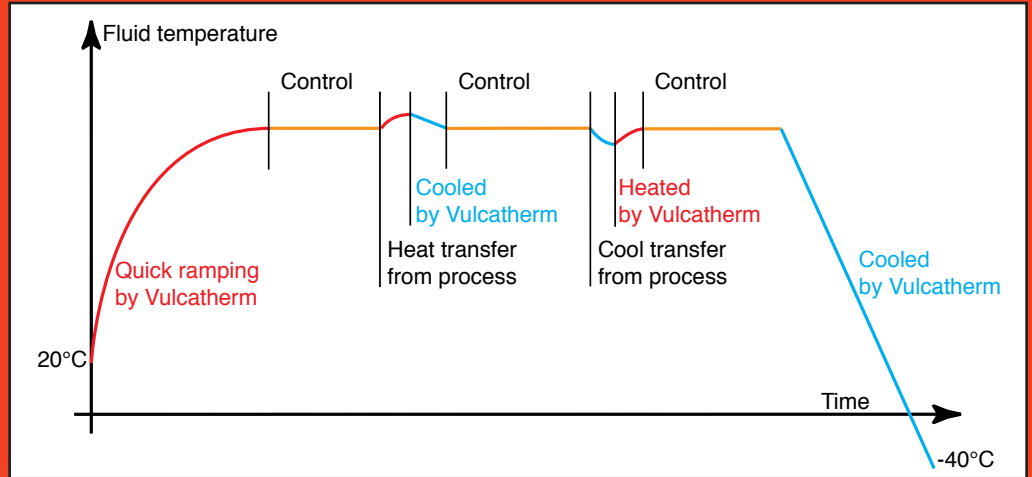

Water-Cooled or Air-Cooled condenser



### PURPOSE

VULCATHERM® is designed to heat, cool and control a fluid medium in a closed loop of a process (mould, double-jacket vessel, equipment, reactor,...). Medium cooling is achieved by an integrated unit.

### PERFORMANCES

-  : Temperature -30 to 140°C
-  : Temperature -40 to 250°C
-  : Heating Capacity 4 to 245 kW
-  : Cooling Capacity 4 to 100 kW

### CHARACTERISTICS

- Electrical heater : Compact technology with continuous heater surface temperature to prevent degradation of fluid.
- PID Temperature control.
- Heating capacity control by thyristors, cooling with integrated cooling unit electronic expansion.
- Fluid superposition technology®
- Centrifugal pump with magnetic seal.
- Refrigerant gas HFC.
- Atmospheric or pressurised (up to 140°C for water medium and 250°C for oil medium).

### LAYOUT

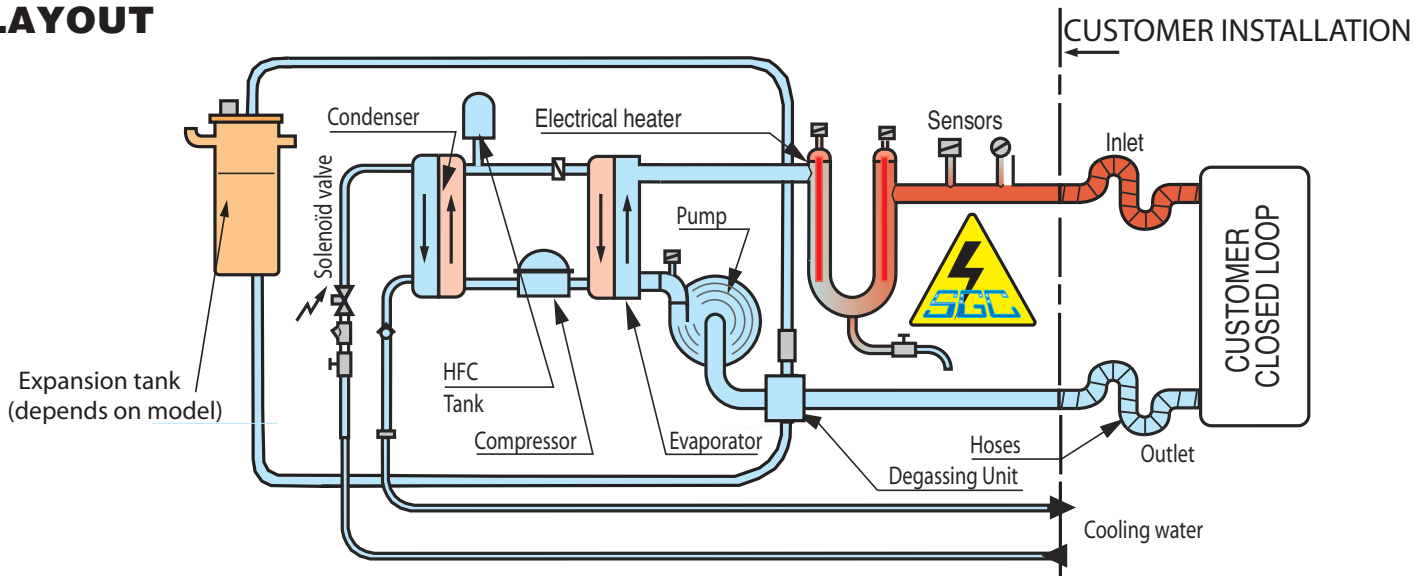



# VULCATHERM® ELECTRICAL BOILERS



**HEATING** Available with a choice of different options

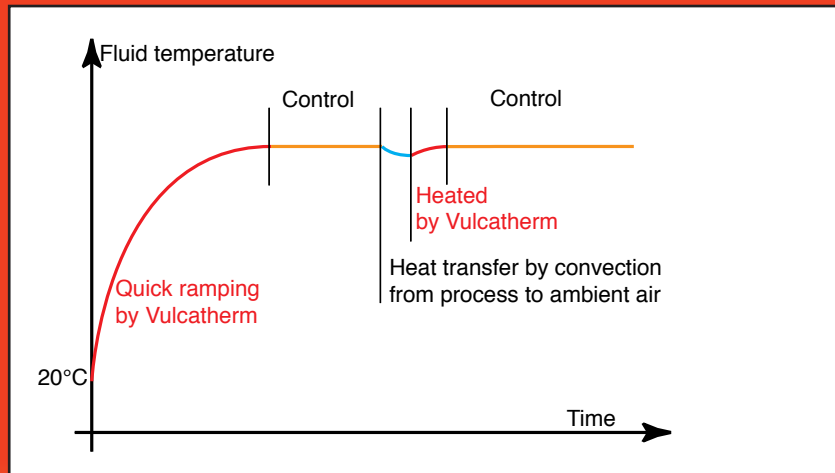

## PURPOSE

VULCATHERM® is designed to heat and control temperature of a fluid medium through a process application (mould, double-jacket vessel, equipment,...).

Electric Boilers are engineered to perform as an efficient unit for hot water or oil heating system and offer excellent benefits.

## PERFORMANCES

: Temperature 90 to 180°C/200°C

: Temperature 150 to 350°C/400°C

: Heating Capacity 4 to 245 kW

## CHARACTERISTICS

- Electrical heater : Compact technology with continuous heater surface temperature to prevent degradation of fluid.
- PID Temperature control.
- Heating capacity control by thyristors.
- Centrifugal pump.
- Atmospheric or pressurised (up to 200°C for water medium and 400°C for oil medium).

## LAYOUT

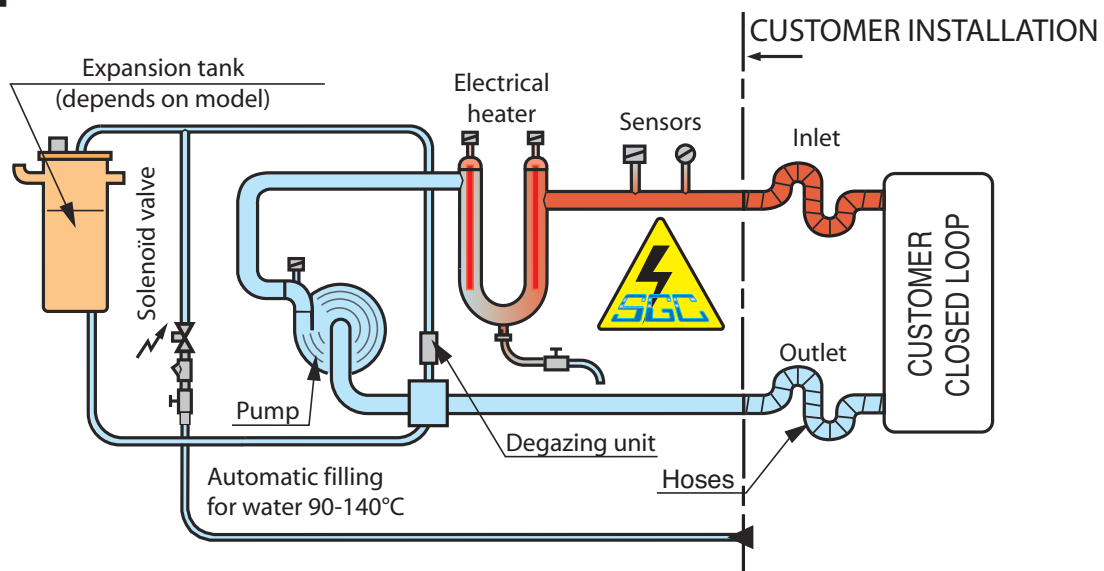



# VULCAFROID® CHILLERS



- STANDARD OR CUSTOMIZED SOLUTION
- PLUG & PLAY
- EASY ACCESS / HANDLING
- DESIGNED FOR 24H/DAY OPERATION
- HIGH LIFE TIME
- PORTABLE OR SKID MOUNTED
- FLOW RATE VARIATION FROM 0 TO 100%.
- OUTDOOR INSTALLATION OPTION

## PURPOSE

Vulcafroid® chillers cool fluids with high accuracy control.

## PERFORMANCES

- : Temperature -30°C to 25°C
- : Cooling Capacity 1,5 to 50 kW  
Standard Temperature : 10°C
- : Ambient air temperature : 35°C.

## CHARACTERISTICS

- Ingress protection level IP53.
- Electronic control.
- Insulated stainless steel tank.
- Refrigerant gas HFC.
- Long life time aluminium/copper heat exchanger with high efficiency.

## LAYOUT

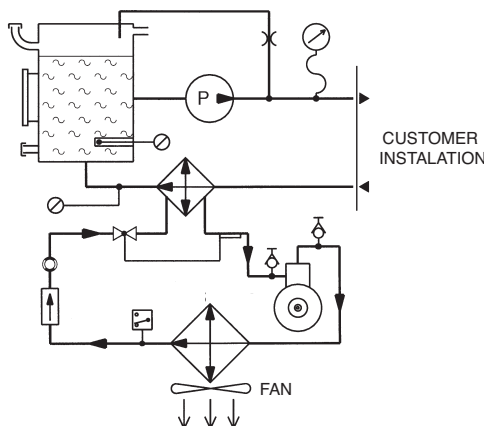



# AIR CONDITIONING UNITS & EXCHANGERS FOR ELECTRICAL CABINET

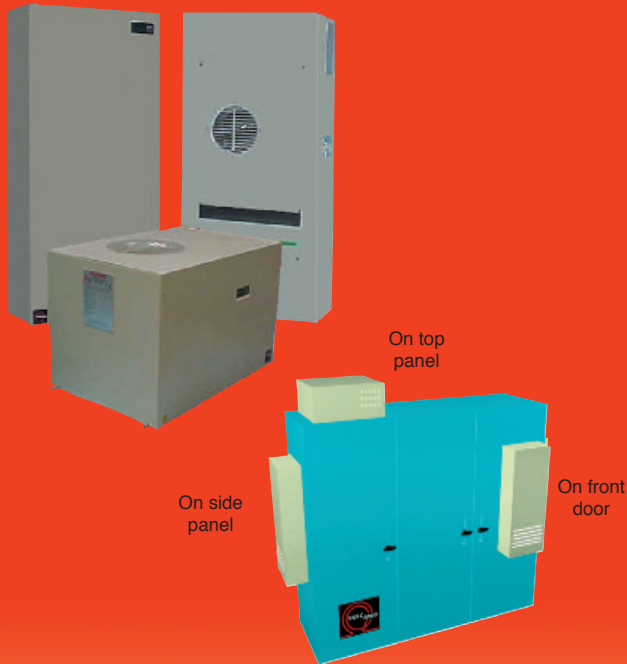



- PLUG & PLAY
- SUITABLE FOR CORROSIVE ATMOSPHERE (oil, dust,...)
- REDUCED MAINTENANCE
- HIGH LIFE TIME FILTER
- TOP OR SIDE MOUNTING
- STANDARDISED CABINET CUT OUT

## PURPOSE

Air conditioners provide cooling within electrical cabinets to ensure safe and reliable performance by protecting temperature sensitive electronics. A maximum cabinet operating temperature of 35°C is maintained. Engineered and manufactured to endure the most challenging environments.

## PERFORMANCES

 : Temperature 26°C to 40°C

 : Cooling Capacity 360 to 6000 W



Standard electronic controller

## CHARACTERISTICS

### • Air conditioners

Refrigerant gas HFC  
Powerless condensation evaporating device  
Standard spare parts for all models  
Hermetic compressor with 80 000 hours MTBF

### • Air / Water exchangers

Evaporating unit in Copper / Aluminium  
Electronic control with door contact security  
Wide fin pitches to avoid filter pollution

## LAYOUT

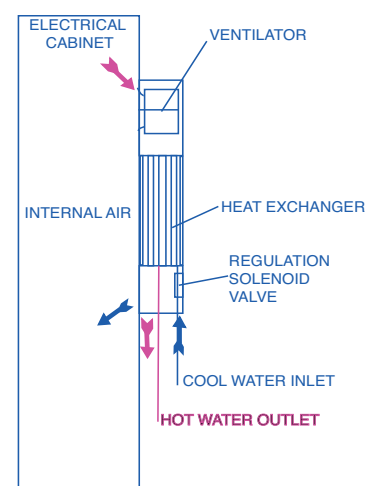
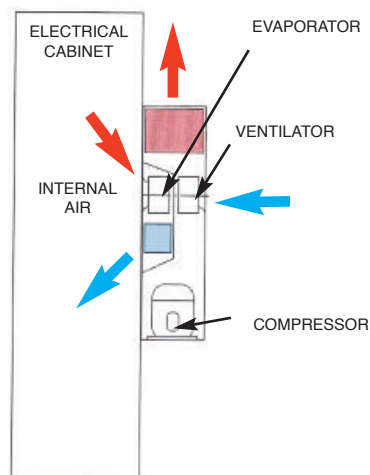



# INDUSTRIAL DEHUMIDIFIERS

## EDENAIR®

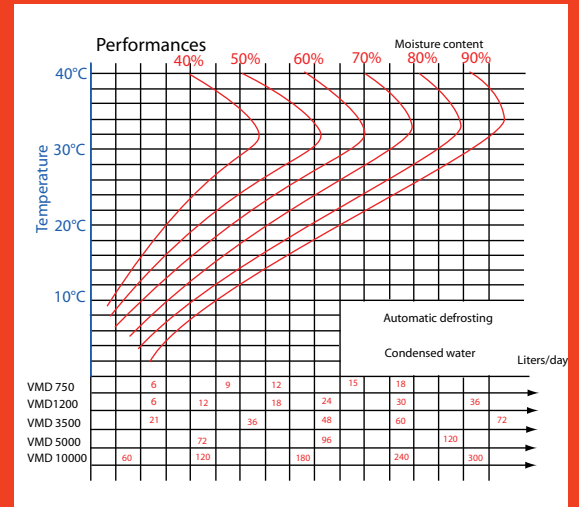
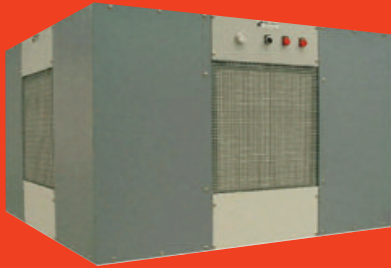

- PORTABLE, FIXED OR AIR DUCTED SOLUTIONS

- SUITABLE FOR CORROSIVE ATMOSPHERE (Chlore, dust, air pollution...)

- COLD EXCHANGER WITH HIGH LEVEL OF EFFICIENCY

- DESIGNED FOR 24H/DAY OPERATION

- EASY ACCESS

- COMPACT, MODULAR CASING

- LONG LIFE TIME

## PURPOSE

EDENAIR® dehumidifiers are the perfect solution to remove excessive moisture from air and material preventing moisture induced damage.

They are well known for their effectiveness in applications such as :

Stocks rooms, swimming pools, cellars, bunkers, silos, laboratories, dryers (wood, plaster, paper...), construction sites, food & beverage production, archives, museums, workshops, greenhouses, gymnasiums, residential houses, boats,.

## PERFORMANCES

- From 100 to 8000 m<sup>3</sup> treated air
- From 6 to 300 l / day condensed water
- Humidity rate : Accuracy ± 7%

## CHARACTERISTICS

- Remote control.
- Automatic defrosting.
- Evacuation pump for condensed water.
- Electrical heating or not hot water, heat exchange can be combined to ensure optimal comfort.

## SOME CUSTOMISED SOLUTIONS :



**Vulcatherm® Heating / Cooling**  
 Thermal fluid : Water  
 T° range : 20 / 110°C  
 Heating Power : 30 kW (5 x 6 kW)  
 ATEX Certified  
 6 separated controlled circuits



**Vulcatherm® Heating / Cooling**  
 Thermal fluid : Oil  
 T° range : 10 / 200°C  
 Heating / Cooling Power : 80 / 50 kW  
 Air-Cooled condenser



**Vulcatherm® Heating / Cooling**  
 Thermal fluid : Oil  
 T° range : 20 / 250°C  
 Heating / Cooling Power : 250 / 250 kW  
 PED 97/23/CE Category IV Certified



**Vulcatherm® Heating / Cooling**  
 Thermal fluid : Synthetic Oil  
 T° range : 10 / 250°C  
 Heating / Cooling Power : 20 / 25 kW at 10°C  
 Fluid superposition technology®



**Vulcatherm® Heating / Cooling**  
 Thermal fluid : Water  
 T° range : 20 / 140°C  
 Heating Power : 50 kW (5 x 10 kW)  
 5 separated controlled circuits  
 PLC controlled



**Vulcafroid®**  
 Thermal fluid : Water + glycol  
 T° range : 5 / 30°C  
 Cooling Power : 60 kW  
 Air-Cooled condenser





**VULCANIC SAS**  
ZI des Chanoux  
48, rue Louis Ampère  
F-93330 Neuilly sur Marne  
France  
Tel. : +33 1 49 44 49 20



**VULCANIC UK Ltd**  
South Green Park Enterprise  
Centre, Mattishall  
NR20 3JY, Dereham Norfolk  
United Kingdom  
Tel. : +44 1603 340015



**VULCANIC SAS**  
ZI la Saunière  
F-89600 Saint Florentin  
France  
Tel. : +33 1 49 44 49 20



**VULCANIC SA**  
Heilig Hartstraat, 14  
B-2600 Berchem  
Belgium  
Tel. : +32 3 286 70 30



**LOREME SAS**  
12, rue des Potiers d'Etain  
Actipôle Borny  
F-57071 Metz  
France  
Tel. : +33 3 87 76 32 51



**VULCANIC TERMOELÉCTRICA SLU**  
Ctra. a Viérnoles, 32  
E-39315 Torrelavega  
Spain  
Tel. : +34 942 80 35 35



**RS ISOLSEC SAS**  
45, avenue des acacias  
F-45120 Cepoy  
France  
Tel. : +33 2 38 85 62 62



**RS ISOLSEC SLU**  
Ave Riu Mogent, 5  
E-08170 Montornes del valles  
Spain  
Tel. : +34 93 568 73 10



**VULCANIC GmbH**  
Donaustraße 21  
D-63542 Hanau  
Germany  
Tel. : +49 6181 9503 0



**VULCANIC TRIATHERM GmbH**  
Flurstraße 9  
D-96515 Sonneberg  
Germany  
Tel. : +49 3675 4083-0



**Your dedicated contact**

**ALL IN ONE SOLUTIONS**